

# Wearing of seat belt

## Correct wearing of seat belt

The seat belt might reduce the effect by half, and be dangerous if it doesn't correctly wear it. Those who drive must wear without fail according to the following use before it runs, and let me wear it to those who multiply this.

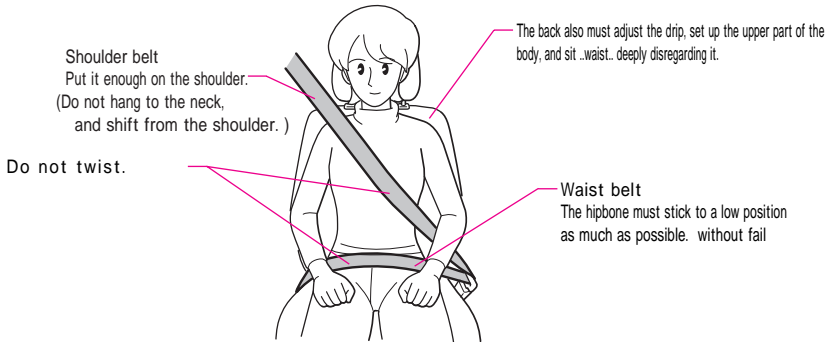

**警告**

**Wear the seat belt. Moreover, guard the following when you wear it.**

- All members must wear the seat belt when you take the car. In the worst case, it reaches important injury or, it is likely to lead to the death by the body's not being maintained in the seat when time that slammed on the brakes and colliding if the belt is not worn, throwing, flying to the swelling SRS air bag the body, and being thrown out outside the car. -

Guard the following when you wear the seat belt. In the worst case, the effect with an enough seat belt is not demonstrated when colliding if it doesn't defend, it reaches important injury or, it is likely to lead to the death.

蘆Set up the upper part of the body, and wear the seat belt to the seat deeply in the waist or the state of the digit.

Refer to P.155 for the good posture.

蘆Do not wear the shoulder belt by hanging to the neck and passing the armpit. Wear it to take enough to the shoulder.

蘆The waist belt must make it stick to a low position as much as possible and wear the hipbone. When colliding, strong pressure might be received to the abdomen etc. when the waist belt shifts from the hipbone.

蘆Wear it so that there is no seat belt splash fret. When colliding, the impact power cannot be distributed enough when twisting.

蘆The seat belt is for one person. Do not use the belt of one every two people or more.

蘆Do not apply slack with the clothespin and the clip, etc. when you wear the seat belt.

蘆The back of the seat must not run knocking down the drip more than the necessity either. When colliding, the body might receive strong pressure from the seat belt under to diving and the abdomen, etc.

蘆Do not drive approaching the steering wheel and the Instrument panel more than the necessity.



## Wear the seat belt. Moreover, guard the following when you wear it.

- Place neither seat belt nor the plate between the seat and the door. In the worst case, an enough effect is not demonstrated when the seat belt is damaged, it reaches important injury or, it is likely to lead to the death. -

Let the child wear the seat belt, too. Might it be not possible to finish supporting when a rapid brake and colliding when the child is embraced on the knee, the child throw out, and it reaches important injury or, in the worst case, it lead to the death. -

The be getting pregnant woman also must wear the seat belt.

(However, confirm notes to the doctor. )

蘆Wear wearing the seat belt under the pregnancy under the swelling of the stomach so that the waist belt may hang to the position where the hipbone as possible is as low though it is basically similar to the time usually worn.

Moreover, surely avoid the swelling of the stomach through the shoulder and wear the shoulder belt to hang to the chest.

蘆In the worst case, not only the mother's body but even also the embryo reaches important injury or, it is likely to lead to the death by the belt's digging into to the swelling of the stomach when time that slammed on the brakes and colliding if the belt has not been correctly worn. -

Wear the seat belt if you have the disease.

(However, confirm notes to the doctor. )





**Wear the seat belt. Moreover, guard the following when you wear it.**

- The seat belt hits the neck and the jaw, and the child seat junior seat is used for a small child who doesn't hang to the hipbone. Strong pressure is received when colliding when not using it, and it reaches important injury or, in the worst case, it is likely to lead to the death. Moreover, a small child of one sitting who cannot do must use the baby seat. Consult the Toyota shop about the seat only for the child.

Standard of selection of seat only for child(For a Toyota pure goods. )

Child seat baby seat fixed with bar & Topptezarancar only for child seat fixation for ISOFIX of this car

Exclude the following.

	Weight	Height	Reference age
Baby seat	..less than	..less than	Four years old of nine months
Child seat	9kg.. 9-18kg	70cm.. 70-100cm	of newborn baby - nine months-

	Weight	Height	Reference age
Baby seat	Less than 10kg	75-105	Newborn baby Four years old
Child seat	9. 18kg	..75cm or less..cm	of nine months of -12 months-
junior seat	15. 32kg	100-135cm	four years old - ten years old

- The foreign body must not enter the buckle of the seat belt. In the worst case, the effect with an enough seat belt is not demonstrated when the plate might not completely fit in the buckle when the foreign body enters, and it collides, it reaches important injury or, it is likely to lead to the death. - It becomes loose, it is possible to be worn out, and exchange the seat belt that doesn't operate normally at once for the new article of pure Toyota. Moreover, receive the high impact due to the accident, and exchange the seat belt that attaches the wound at once without using it for the new article. In the worst case, it doesn't work normally when colliding when using it as it is, the effect with an enough seat belt is not demonstrated, it reaches important injury or, it is likely to lead to the death. -

Remodel, resolve or neither installation nor detach the seat belt. The effect with an enough seat belt is not demonstrated when colliding, and it reaches important injury or, in the worst case, it is likely to lead to the death. Consult the Toyota shop about the installation, detaching, and the exchange of seat belts. -

Do not use organic solvents such as benzine and gasoline to clean the seat belt. Moreover, do not bleach, and do not dye the belt. Important injury that doesn't demonstrate the effect with an enough seat belt when the performance of the seat belt falls, and it collides and is related to the life might be received and it is dangerous. Do not use the seat belt until drying by using the soapless soap or lukewarm water when you clean it.

## How to wear seat belt

Exclude Secandoshet central seat of seven person getting on car.

### How to detach seat belt

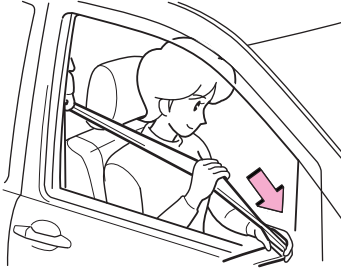

- 1 Draw out the seat belt.  
Confirm drawing out the plate having it, and no twist.  
Loosen the belt after strongly pulling the belt once, and draw it out again slowly when it is not possible to draw it out with the seat belt locks.

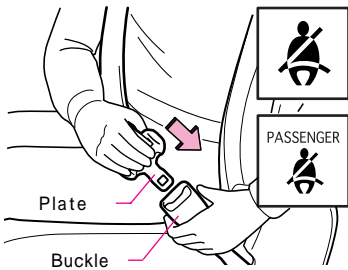

- 2 Insert the plate in the buckle.  
Insert the plate in the buckle until "Catitsu" and the sound are heard.  
Confirm to the reception desk seat belt having turned off the seat belt non-wearing warning light (Refer to P.278).

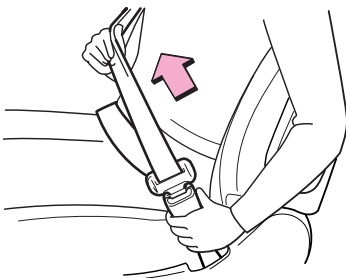

- 3 Make the waist belt stick.  
The waist belt makes the hipbone hang to a low position as much as possible without fail, pulls the shoulder belt, and makes it stick to the waist.

Contents



Warning

Basic  
contents, operationDriving  
Handling  
deviceThe  
Handling indoor  
equipmentGood. Safety  
of  
To  
theory, practice  
and  
equipmentHow  
to  
attention  
associate, aiming,  
car

Maintenance

Myriad  
One(D)C  
with

Index

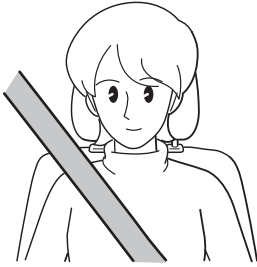

#### 4 Wear the shoulder belt.

The shoulder belt makes it hang enough to the shoulder without fail.

At this time, the belt doesn't hit the neck, and it doesn't shift from the shoulder.

#### SRS curtain shield air bag installation car

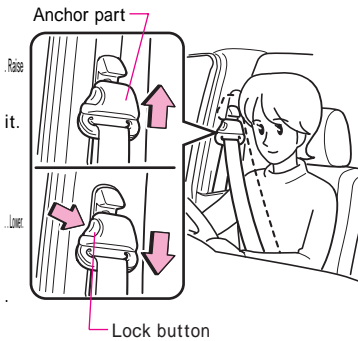

#### 5 In the reception desk seat, adjust the height of the belt.

Adjust the height of the belt as an adjustable seat belt anchor.

The belt must hang to the center of the shoulder as much as possible when adjusting it. - Have the anchor part, and move it as it is when you raise it. -

Move the anchor part with the lock button pushed, and adjust it at the best position when you lower.

Confirm hearing "Catitsu" and the sound, and fixation surely.

#### Exclude the SRS curtain shield air bag installation car.

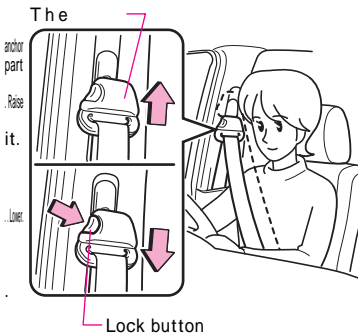

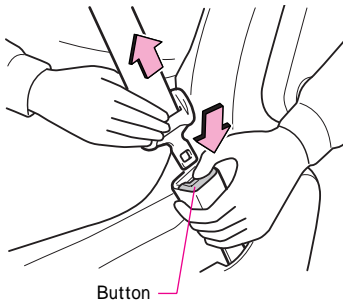

## 6 Push the button of the buckle when you remove.



### Guard the following when you wear the seat belt.

- Pass the seat belt without fail under the armrest and wear it when you use the seat belt of the seat with the armrest. The effect with an enough seat belt is not demonstrated when colliding when wearing it with the seat belt hung to the armrest, and it reaches important injury or, in the worst case, it is likely to lead to the death. -

Guard the following when you adjust the seat belt anchor. The effect with an enough seat belt is not demonstrated when colliding if it doesn't defend, and it reaches important injury or, in the worst case, it is likely to lead to the death.

蘆Adjust it at the position where it is high only for the seat belt to finish not hitting the neck and to take enough to the center of the shoulder.

蘆Confirm fixation surely after it adjusts it.

## How to wear two point expression seat belt

Secandoshet central seat of seven person getting on car

### How to detach seat belt

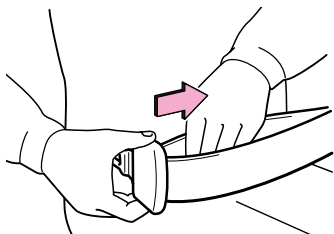

- 1** Adjust the length of the belt.  
Make, pull the belt, and make the plate long from necessary length a little as shown in figure.

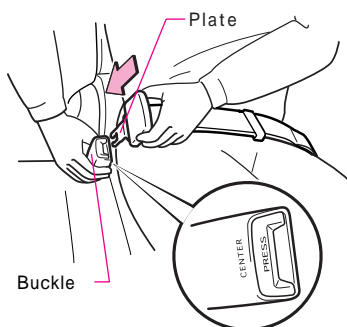

- 2** Unite belts.  
Insert the plate in the buckle until "Catitsu" and the sound are heard so that there is no twist in the belt.

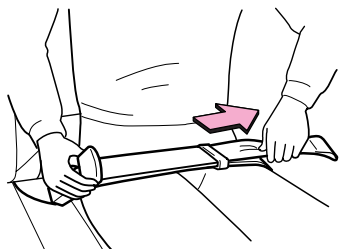

- 3** Make the belt stick.  
Pull the belt and stick to a low position about the hipbone as much as possible. without fail

- 4** Do to remove pushing the button of the buckle when you remove.  
Fix the removed belt into the buckle.



**Guard the following when you wear two point expression seat belt.**

Guard the following when you wear two point expression seat belt. The effect with an enough seat belt is not demonstrated when the seat belt cannot be correctly worn if it doesn't guard, and it collides, and it reaches important injury or, in the worst case, it is likely to lead to the death. - Match and wear the position before and behind a right and left seat. -

The back narrows in the drip and the seat cushion, too or the belt is caught to the band etc. on the part of seat and after it detaches, and it draws it out enough, it wears it.

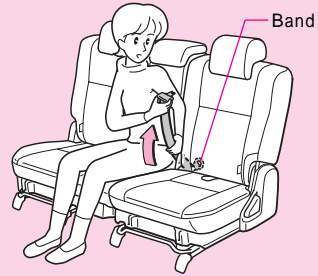

**Knowledge**

**About the storage of Secandoshetobelt**

Seven person getting on car

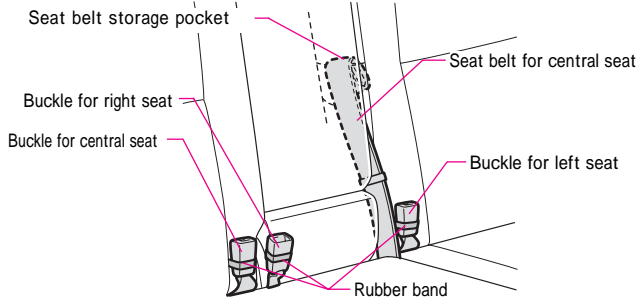

The seat belt or the buckle can be stored as shown in figure. -

The back of a left seat hangs down, too and the seat belt for a central seat inserts and stores the plate in the pocket on the side. -

Always pass the buckle through the rubber band.

**About uniting Secandoshet central seat seat belts**

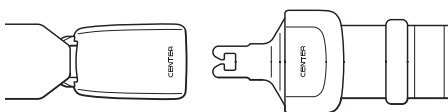

Unite with the plate by the one that there is a stamp of "CENTER" in the buckle. It is not possible to unite with the one with the stamp of "CENTER" in case of not being.

- Contents
- Warning
- Basic cautions, operation
- Driving Handling device
- The Handling indoor equipment
- Good Safety of To theory, practice and equipment
- How to attention associate driving car
- Maintenance
- Myriad One(D)
- Index

# Fixation of child seat

## Secandoshet right and left seat

Bar & Topptezarancar only for the child seat fixation for ISO\*FIX to install the child seat baby seat is installed.  
 Only the child seat baby seat for bar & Topptezarancar only for the child seat fixation for ISOFIX can be installed in bar & Topptezarancar only for the child seat fixation for this ISOFIX.

- "International Organization for Standardization" is meant by abbreviating International Organization for Standardization.

- Installation position

### Seven person getting on car

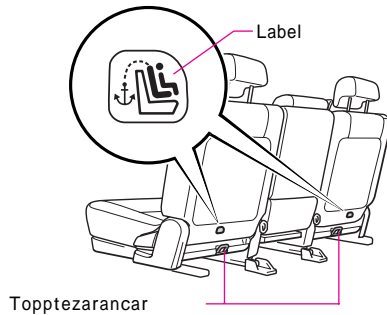
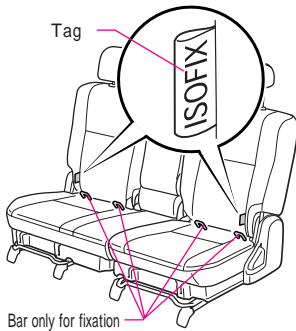

### Six person getting on car

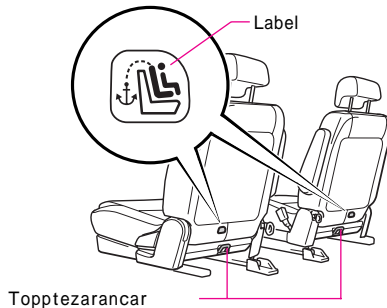
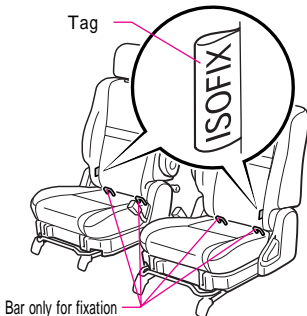

- There are a seat cushion and a back in the bar only for fixation for the drip, too.

蘆..tag (.. surface where bar only for fixation shows equipment「ISOFIX」 ·Back Respect「LATCH」 ) is seated to the seat. -

Topptezarancar is in Shetocstion Gawa.

蘆The label that shows equipment with Topptezarancar attaches.

## Fixation with bar & Topptezarancar only for child seat fixation for ISOFIX

- 1 Adjust the positions most before and behind Secandoshet to. Refer to P.161.
- 2 Improve the headrest of Secandoshet to the place where "Catitsu" and the sound are heard. Confirm the headrest is fixed.

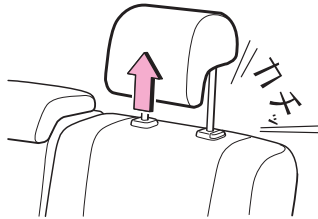

- 3 Confirm the position of bar & Topptezarancar only for the child seat fixation for ISOFIX. Refer to last page.

Contents



Warning

Basic  
contents, operationDriving  
Handling  
deviceThe  
Handling indoor  
equipmentGood. Safety  
of  
To  
theory/vehicle  
and  
equipmentHow  
to  
attention  
associate driving  
car

Maintenance

Myriad  
One(D)と  
with

Index

## 4 Install the seat (child seat baby seat) only for the child in Secandoshet.

Install the installation metal fittings of the seat only for the suited child in the bar only for fixation. Next, install Tezarbelt in Topptezarancar.

\*Read the manual of the attachment each commodity the installation method and how to detach it.

- Install it after the back of the seat also adjusts the angle of the drip for the back of the seat to do the space between seats only for the drip, the seat cushion, and the child. -

Pass between headrests, and multiply Tezarfcc by vehicle side Topptezarancar as shown in the figure below so that Tezarbelt should not twist. - Strongly pull part A until Tezarbelt picks up the slack, and fix the seat only for the child.

Child of less than 9kg(For newborn baby - about nine months.)

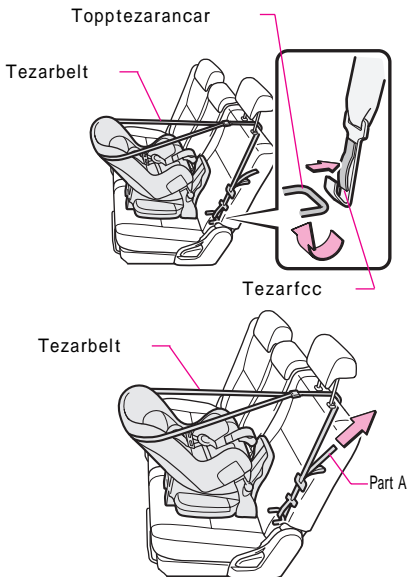

Child of 9kg-18kg(..about four ability of nine months-...)

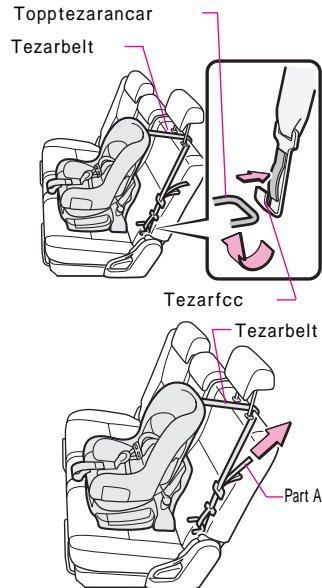

- The illustration is the one for the explanation, and it differs from the shape of the seat only for an actual child.

## 5 Confirm fixation surely.

Confirm the light shake of the seat only for the child who installed it, and the installation surely.



Confirm the seat only for the child is fixed.

- When the seat only for the child is installed, confirm there is neither foreign body around bar & Topptezarancar only for the child seat fixation for ISOFIX is a god not all-in of the seat belt etc. In the worst case, it flies when the seat only for the child is not fixed when the foreign body and the seat belt, etc. are bitten and it crowds, and it collides, it reaches important injury or, it is likely to lead to the death. -

It might cause an unexpected accident by hitting the crew and the one, etc. when having applied the brakes when indoors leaving it with the seat only for the child detached and is dangerous. -

Multiply the tension until Tezarbelt picks up the slack without fail when you install the seat only for the child. The important injury related to the life when colliding might be received if Tezarbelt doesn't correctly put it and it is dangerous.

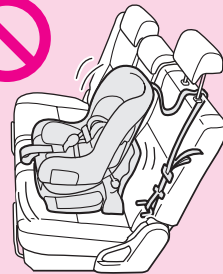
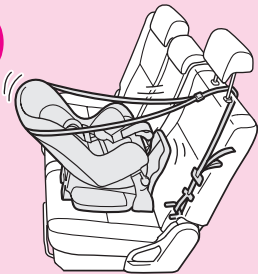

- Pass Tezarbelt under the headrest. The important injury related to the life when the seat only for the child is not firmly fixed when multiplying on the headrest, and it collides might be received and it is dangerous.

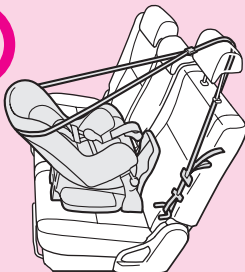



Guard the following when you fix the seat only for the child with Topptezarancar.

- Do not lower the headrest after the headrest is improved and it fixes to Topptezarancar when you install the seat only for the child with the headrest raised. In the worst case, the seat only for the child moves when Tezarbelt's hitting the headrest if the headrest is lowered, slackening, and colliding, it reaches important injury or, it is likely to lead to the death.

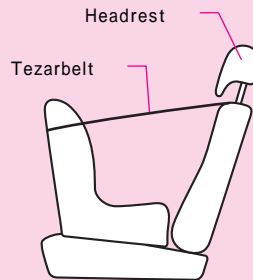
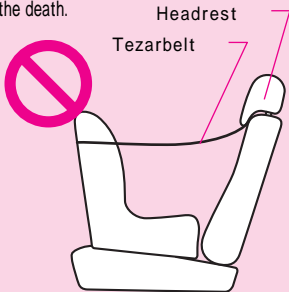

Store in the luggage room or remove from the vehicle and keep it when you do not use the seat only for the child for a long term. The seat might discolor, and the type collapse when it is left to install it in the seat.



#### About bar & Topptezarancar only for the child seat fixation for ISOFIX

Only the seat (Toyota pure child seat baby seat for bar & Topptezarancar only for the child seat fixation for ISOFIX) only for the child who suits the security standard of the road transportation vehicle of the wish specification can be installed in bar & Topptezarancar only for the child seat fixation for this ISOFIX. Consult the Toyota shop in detail.

## Fixation with seat belt

### Secandoshet right and left seat

#### How to use of the child seat fixation mechanism.

- 1 Cause Secandoshet when you do Secandoshet in reclining.  
Refer to P.161.

- 2 Install the seat belt.  
Install the seat belt in the seat (child seat and baby seat) only for the child, and insert the plate in the buckle until "Catitsu" and the sound are heard.  
Read the manual of the attachment each commodity the installation ... method.

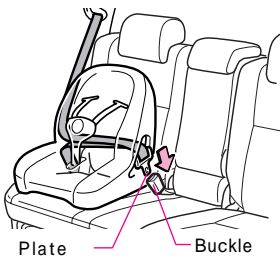

- 3 Draw out the shoulder belt.  
Draw out the shoulder belt slowly to the last minute fully until stopping. - Only the direction up which it winds up operates (lock mode).

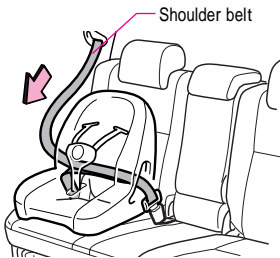

- 4 It is necessary to wind up up the shoulder belt.  
It is necessary to wind up up the shoulder belt until becoming tight the belt while suppressing it to the rear seat putting weight on the seat only for the child. - Confirm the belt doesn't move in the direction of drawing out.

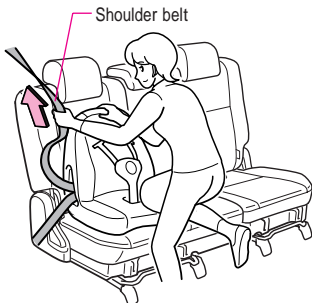

- The illustration is the one for the explanation, and it differs from the shape of the seat only for an actual child.

---

## 5 Confirm fixation surely.

Confirm the light shake of the installed seat, and fixation surely.

## Release of child seat fixation mechanism

When it unbuckles, and it winds up up the belt fully, the child seat fixation mechanism is released.



Often read the manual of the attachment and obtain the installation of the seat only for the child for the commodity correctly.

- In the worst case, it reaches important injury by flying when time that slammed on the brakes and colliding if not correctly installed or, it is likely to lead to the death. -
- It might cause an unexpected accident by hitting the crew and the one, etc. when having applied the brakes when indoors leaving it with the seat only for the child detached and is dangerous. -
- Do not let the child play with the child seat fixation mechanism addition seat belt. The belt cannot be drawn out when it operates the child's playing with the seat belt and by mistake, and the belt coils around the neck by any chance, and it reaches important injury like suffocation etc. or, in the worst case, it is likely to lead to the death. Cut the seat belt with scissors etc. when it enters such a state by any chance by mistake, and the buckle cannot be removed.



Store in the luggage room or remove from the vehicle and keep it when you do not use the seat only for the child for a long term. The seat might discolor, and the type collapse when it is left to install it in the seat.



## Knowledge

### About the seat belt with the child seat fixation mechanism

- The seat belt with the child seat fixation mechanism is built into the seat belt of Secandoshet. When the child seat baby seat is installed, it is convenient because the belt can be prevented from moving in the direction of drawing out. -

The child seat fixation mechanism might operate when big movement of the upper part of the body is done with the seat belt worn. In that case, wear the seat belt again after releasing the child seat fixation mechanism of unbuckling once, and winding up up the belt fully.

Fix the seat only for the child who suits the security standard of the road transportation vehicle with bar & Topptezarancar only for the child seat fixation for ISOFIX in fixation by bar & Topptezarancar only for the child seat fixation for ISOFIX of this car, and give to me in the seat belt of this car in the melting pot. (Refer to P.205 for bar & Topptezarancar only for the child seat fixation for ISOFIX. )

Contents



Warning

Basic  
causes, operationDriving  
Handling  
deviceThe  
Handling indoor  
equipmentGood Safety  
of  
To  
theory, vehicle  
and  
equipmentHow  
to  
attention  
associate driving  
car

Maintenance

Myriad  
One(D)と  
with

Index